

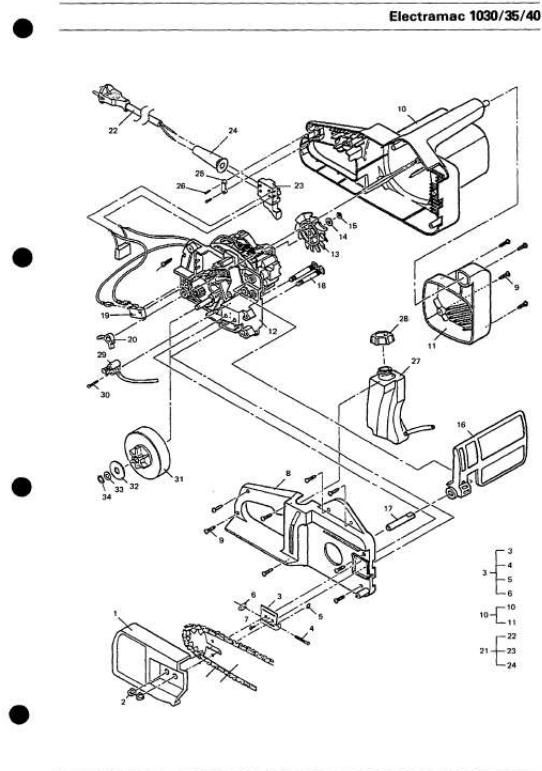

# Your PDF Guides

You can read the recommendations in the user guide, the technical guide or the installation guide for MCCULLOCH ELECTRAMAC 1035. You'll find the answers to all your questions on the MCCULLOCH ELECTRAMAC 1035 in the user manual (information, specifications, safety advice, size, accessories, etc.). Detailed instructions for use are in the User's Guide.

**User manual MCCULLOCH ELECTRAMAC 1035**  
**User guide MCCULLOCH ELECTRAMAC 1035**  
**Operating instructions MCCULLOCH ELECTRAMAC 1035**  
**Instructions for use MCCULLOCH ELECTRAMAC 1035**  
**Instruction manual MCCULLOCH ELECTRAMAC 1035**



[You're reading an excerpt. Click here to read official MCCULLOCH ELECTRAMAC 1035 user guide](http://yourpdfguides.com/dref/3598980)  
<http://yourpdfguides.com/dref/3598980>

*Manual abstract:*

/i 27 .:<< 30 34 3 4 3 5 { 1 10 6 10 11 -E + 22 21 23 24 q Electramac 1030/35/40 WIRING DIAGRAM MAIN 2 POLE KICK BACK SWITCH SWITCH \* @  
McCulloch Gmbh Bochum 44805 Shop-Vat France, Evry Cedex 2851 Goblin 91028 @ Fam Nederland B.V. @@3. 4. 5. 6. 7. 8. @@12.

13. 14. 15. 16. 17.

18. 19. 20. 21. @ o @ 22: @ @ @ 23.

24. 25. 26. 27. 28. 29. 30. 31. 32. 33.

34. @ @ @ @ @ @ .



[You're reading an excerpt. Click here to read official MCCULLOCH  
ELECTRAMAC 1035 user guide  
http://yourpdfguides.com/dref/3598980](http://yourpdfguides.com/dref/3598980)